

1M 3-CIRCUIT DALI TRACK

3-CIRCUIT DALI TRACK SYSTEM



COLOURS



OPTIONS

Dimmable



Product code Black (RAL 9011)

EAN Code Black

PRO-0610-B

8719747931271

Product code White (RAL 9010)

EAN code White

PRO-0610-W

8719747931257

Product code Grey (RAL7040)

EAN code Grey

PRO-0610-S

8719747931264

Main materials

Net weight per piece

Inner box / outer box

Rated voltage per circuit

Copper + Aluminum

918 grams

1 / 6 pcs

230V / 16A

DIMENSIONS

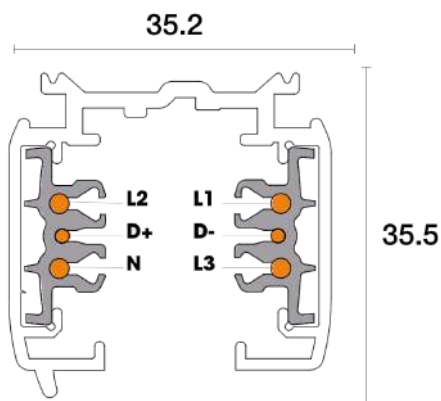

CONNECTING DIAGRAM

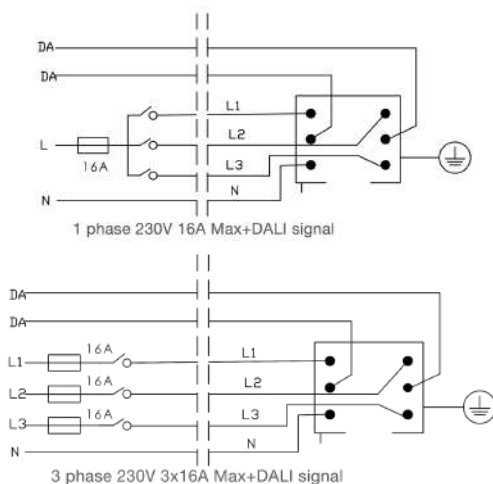

MECHANICAL LOAD DIAGRAM

