

3M 3-CIRCUIT DALI TRACK

3-CIRCUIT DALI TRACK SYSTEM



COLOURS



OPTIONS

Dimmable



Product code Black (RAL 9011)
EAN Code Black

PRO-0630-B
8719747931332

Product code White (RAL 9010)
EAN code White

PRO-0630-W
8719747931318

Product code Grey (RAL7040)
EAN code Grey

PRO-0630-S
8719747931325

Main materials
Net weight per piece
Inner box / outer box
Rated voltage per circuit

Copper + Aluminum
2754 grams
1 / 6 pcs
230V / 16A

DIMENSIONS

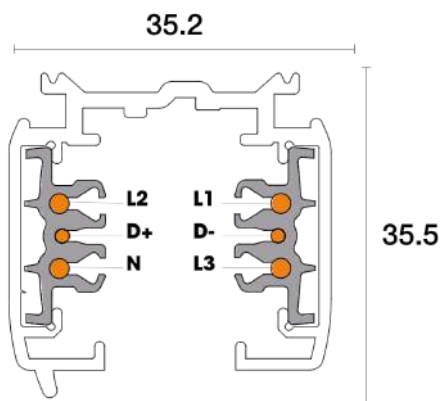

CONNECTING DIAGRAM

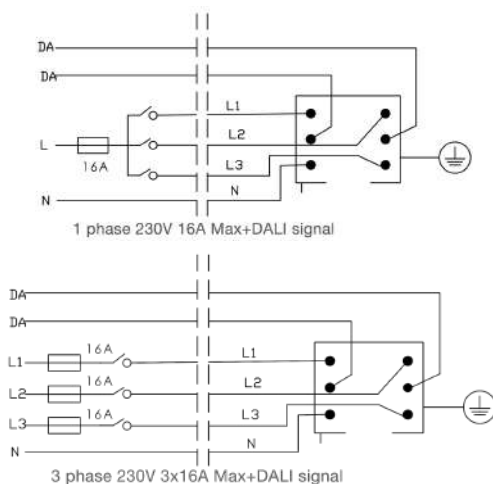

MECHANICAL LOAD DIAGRAM

