

LED NEON STRIP D18mm 360° IP67

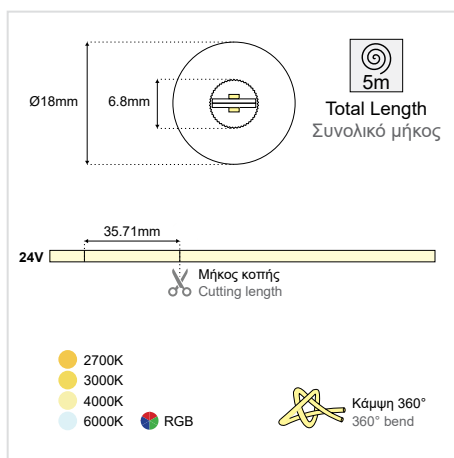

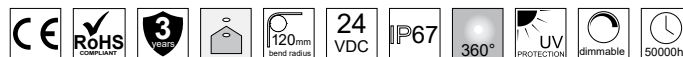

GENERAL INFORMATION

APPLICATION	Indoor / Outdoor
MATERIAL	Silicone
COLOR	White
DIMENSIONS (Ø)	Ø18mm
MAXIMUM LENGTH	5m
CUTTING LENGTH	35.71mm
IP PROTECTION	IP67
WORKING ENVIROMENT TEMPERATURE	-40°C - +60°C
UV-PROTECTION	Anti-UV
INCL. CABLE	Yes
ELECTRIC GEAR	Not included
LIFETIME	50000 hours
WARRANTY	3 years
ORIGIN	PRC

ILLUMINANT

LAMPTYPE	SMD2835 LED
LED QTY	168 LEDs/m
VOLTAGE	24VAC
WATTAGE	14.4W/m
BEAM ANGLE	360D
OUTPUT	1000Lm/m
DIMMABLE	PWM

LED NEON STRIP D18mm 360° IP67

Available colors		SKU
2700K		E9010805-046
3000K		E9010805-042
4000K		E9010805-043

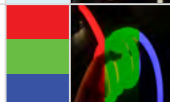
Available colors		SKU
6000K		E9010805-044
RGB		E9010805-045

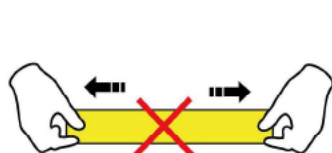
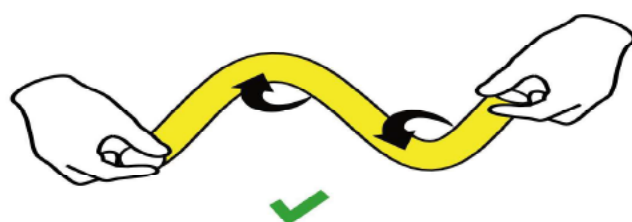

Μην τεντώνετε την ταινία
No stretching

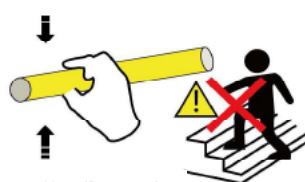

Μην πιέζετε την ταινία
No pressing

TO BE USED WITH

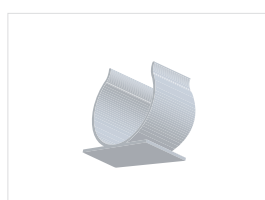

CLIP FOR NEON STRIP D18 360°

SKU: E9010803-029

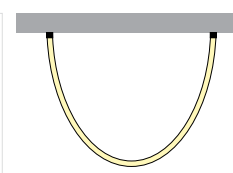
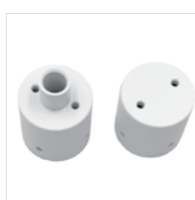
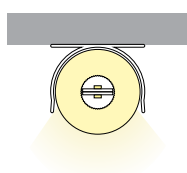

METAL END CAP FOR NEON STRIP D18 360°

SKU: WHITE □ E9010803-040, BLACK ■ E9010803-041



NEON D18-22 R24×30×L45mm SUNSPENSION 1m KIT 1PC

SKU: 00010803-050

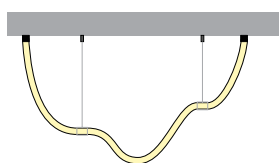

END CAP FOR NEON STRIP D18 360°

SKU: E9010803-024

LED NEON STRIP D18mm 360° IP67

CONNECTION DIAGRAM

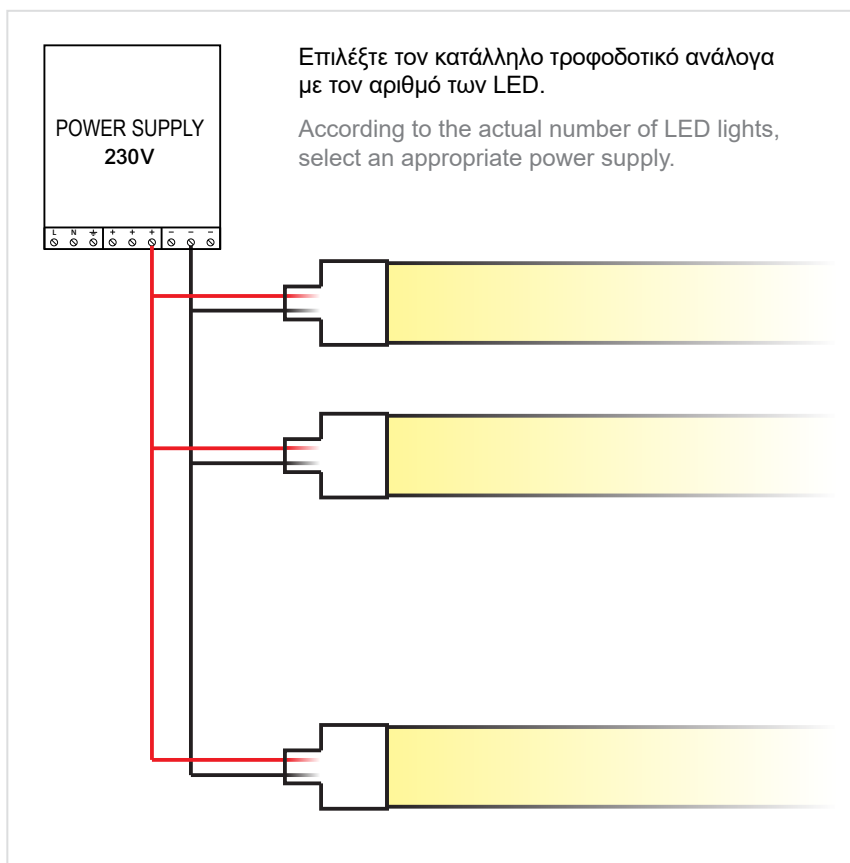

ΣΗΜΑΝΤΙΚΟ:

Αυτό το εξάρτημα πρέπει να εγκατασταθεί από εξειδικευμένο ηλεκτρολόγο.

Η BarisLight δεν φέρει ευθύνη για τυχόν ζητήματα που προκύπτουν από ακατάλληλη εγκατάσταση που δεν συμμορφώνεται με τα τοπικά πρότυπα ασφαλείας.

ΠΡΟΦΥΛΑΞΕΙΣ:

1. Διαβάστε προσεκτικά τις προδιαγραφές πριν χρησιμοποιήσετε το προϊόν.
2. Βεβαιωθείτε ότι το τροφοδοτικό είναι DC 24V.
3. Απαγορεύεται αυστηρά η εργασία σε γραμμές υπό τάση.
4. Μην χρησιμοποιείτε όξιμες ή αλκαλικές κόλλες σε επαφή με το προϊόν.
5. Αποφύγετε να ασκείτε πίεση ή δύναμη στην επιφάνεια των LED.
6. Η εγκατάσταση, επισκευή και συντήρηση πρέπει να γίνεται μόνο από επαγγελματίες.
7. Ελέγξτε όλες τις συνδέσεις πριν την ενεργοποίηση για αποφυγή σφαλμάτων.

IMPORTANT:

This luminaire must be installed by a qualified electrician.

Disclaimer:

BarisLight is not liable for any issues arising from improper installation that does not comply with local safety standards.

PRECAUTIONS:

1. Carefully read the specifications before using the product.
2. Ensure the power supply is 24V DC.
3. Avoid working on live wires under any circumstances.
4. Do not use acidic or alkaline adhesive glues in contact with this product.
5. Avoid pressing or applying excessive force to the LED surface.
6. Installation, repair, and maintenance must be performed by professionals only.
7. Double-check all connections before powering on to prevent errors.