

















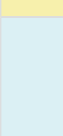











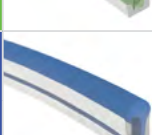













LED NEON STRIP 6×12mm 9W 12V / 24V IP67

	Available colors		Voltage	SKU
2700K				24V E9010805-077
3000K				12V E9010806-009
				24V E9010805-009
4000K				12V E9010806-010
				24V E9010805-013
6000K				12V E9010805-012
				24V E9010806-001
RED				12V E9010805-004
				24V E9010806-012
GREEN				12V E9010806-005
				24V E9010805-005
BLUE				12V E9010806-008
				24V E9010805-011
GOLD YELLOW				12V E9010806-003
				24V E9010805-003
ICE BLUE				12V E9010806-002
				24V E9010805-002
PINK				12V E9010806-006
				24V E9010805-006
LEMON YELLOW				12V E9010806-007
				24V E9010805-007
MALDIVES GREEN				12V E9010806-013
				24V E9010805-041

LED NEON STRIP 6×12mm 9W 12V / 24V IP67

TO BE USED WITH

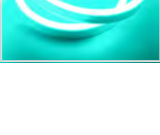
  <p>TRIMLESS ALUMIN PROFILE FOR NEON 6×12mm SKU: 65010803-039</p>	  <p>ALUMINUM PROFILE Π FOR 6×12 NEON LIGHT SKU: 65010803-041</p>
  <p>PROFILE FOR NEON STRIP 6mm PVC 1m PC SKU: 00010803-042</p>	  <p>CLIP FOR NEON STRIP 6mm PVC 5CM PC SKU: E9010803-002</p>
  <p>CURVED STAINLESS STEEL PROFILE 6×12 NEON LIGHT 1m SKU: E9010803-013</p>	 <p>END CAP 6×12mm PC SKU: E9010803-001</p>

LED NEON STRIP 6x12mm 9W 12V / 24V IP67

ΕΓΚΑΤΑΣΤΑΣΗ ΦΟΡΕΑ INSTALLATION OF CARRIER

ΣΗΜΑΝΤΙΚΟ:

Αυτό το εξάρτημα πρέπει να εγκατασταθεί από εξειδικευμένο ηλεκτρολόγο.

Η BarisLight δεν φέρει ευθύνη για τυχόν ζητήματα που προκύπτουν από ακατάλληλη εγκατάσταση που δεν συμμορφώνεται με τα τοπικά πρότυπα ασφαλείας.

Παρακαλούμε δώστε ένα αντίγραφο αυτών των οδηγιών στο άτομο που είναι υπεύθυνο για τη συντήρηση της εγκατάστασης.

IMPORTANT:

This luminaire must be installed by a qualified electrician.

Disclaimer:

BarisLight is not liable for any issues arising from improper installation that does not comply with local safety standards.

Instructions:

Please provide a copy of these instructions to the person responsible for maintaining the installation.

ΟΔΗΓΙΕΣ ΚΟΨΙΜΑΤΟΣ, ΣΦΡΑΓΙΣΗΣ & ΣΥΝΔΕΣΗΣ ΓΙΑ LED NEON CUTTING, SEALING & CONNECTION INSTRUCTIONS FOR LED NEON STRIPS

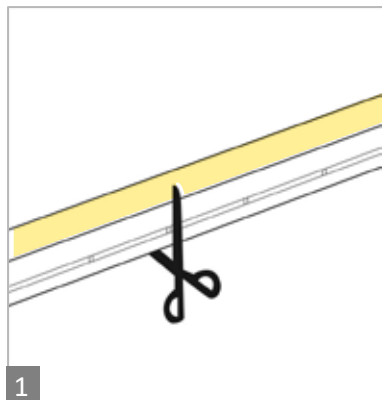

Κόψτε την ταινία στα μαύρα σημεία που έχει στην πλάγια πλευρά της.
Cut along the black points on the side of the strip

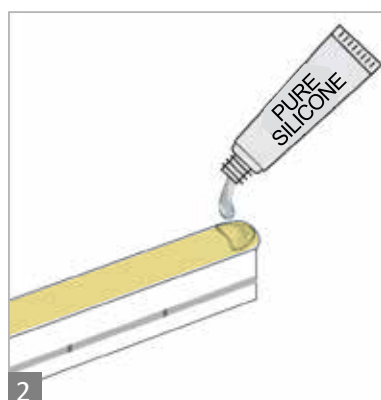

Προσθέστε σιλικόνη στην άκρη.
Apply Pure Silicone on the edge

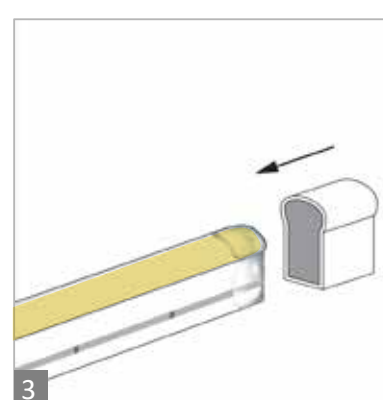

Εφαρμόστε το End Cap for Neon Strip 6x12mm.
Apply the End Cap for Neon Strip 6x12mm

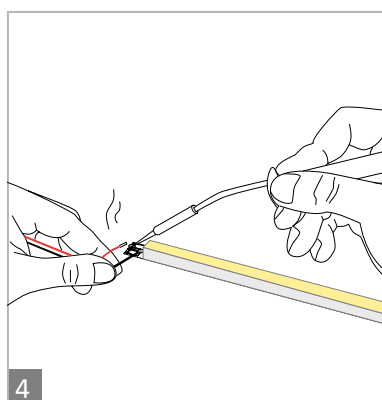

4

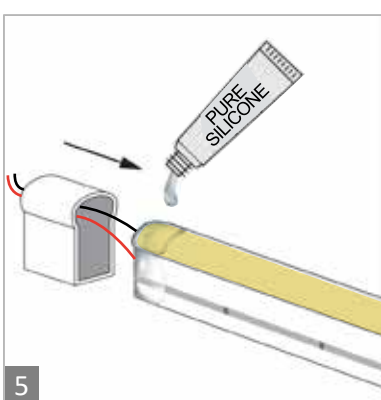

5

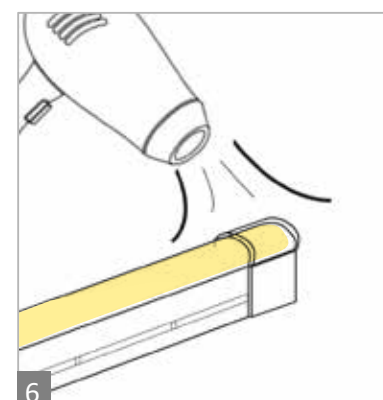

6

LED NEON STRIP 6×12mm 9W 12V / 24V IP67

ΟΔΗΓΙΕΣ ΕΓΚΑΤΑΣΤΑΣΗΣ ΓΙΑ LED NEON INSTALLATION INSTRUCTIONS FOR LED NEON STRIPS

ΤΟΠΟΘΕΤΗΣΗ ΣΕ ΤΡΙΑ ΒΗΜΑΤΑ

Για να αποφύγετε τυχόν ζημιές στη λωρίδα LED κατά την εγκατάσταση, ακολουθήστε αυτά τα βήματα:

1

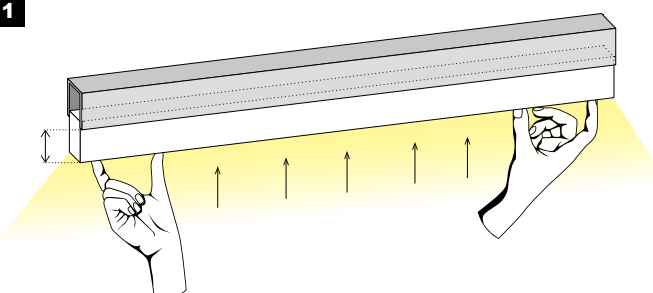

Τοποθετήστε ελαφρά τη λωρίδα LED neon σε όλο το μήκος του προφίλ, χωρίς να την πιέσετε πλήρως.

Lightly place the LED neon strip along the entire length of the profile without pushing it all the way in.

PROPER PLACEMENT IN THREE STEPS

To avoid damaging the LED strip during installation, follow these steps:

2

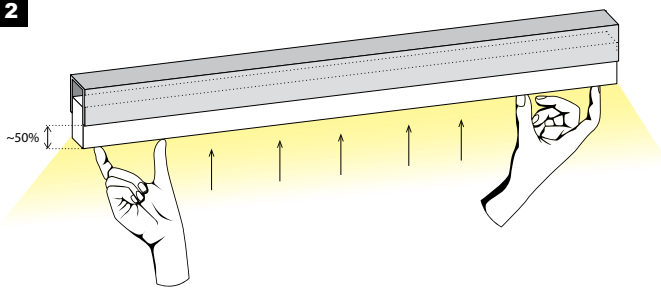

Πιέστε τη λωρίδα μέχρι τη μέση σε όλο το μήκος της.

Press the strip halfway in along its entire length.

3

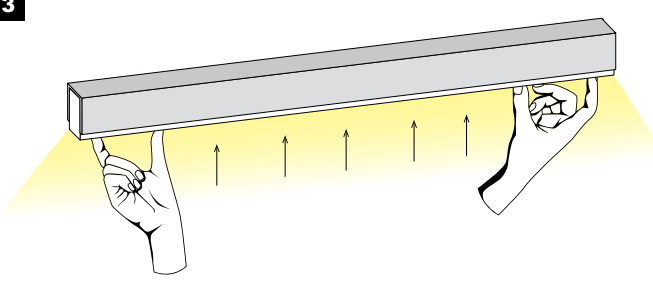

Τέλος, πιέστε την πλήρως μέσα στο προφίλ, εξασφαλίζοντας ομοιόμορφη εφαρμογή.

Finally, fully push it in, ensuring an even fit.

!



ΠΡΟΣΟΧΗ: Απαιτούνται δύο άτομα για την εγκατάσταση LED neon ταινιών άνω των 2 μέτρων ώστε να αποφευχθούν ζημιές.

WARNING: Two people are required for installing LED neon strips longer than 2 meters to prevent damage.

- ✓ Συνιστάται η εγκατάσταση της λωρίδας LED ενώ είναι αναμμένη. Αυτό βοηθά στον εντοπισμό τυχόν συστροφών, ανομοιόμορφης πίεσης ή πιθανών προβλημάτων πριν την οριστική τοποθέτηση.
- ✓ Για ευκολότερη εγκατάσταση και μείωση της πίεσης στη λωρίδα, χρησιμοποιήστε μικρή ποσότητα λιπαντικού (όπως βαζελίνη ή άλλο μη χημικό, μη διαβρωτικό λιπαντικό). Αυτό βοηθά την λωρίδα να γλιστράει μέσα στο προφίλ χωρίς υπερβολική δύναμη.
- ✓ It is recommended to keep the LED strip switched on while installing it. This helps identify any twisting, uneven pressure, or potential damage to the strip before final placement.
- ✓ For smoother installation and to reduce strain on the strip, apply a small amount of lubrication (such as Vaseline or another non-chemical, non-corrosive lubricant). This helps the neon slide into the profile without excessive force.

!



ΠΡΟΣΟΧΗ: Μην ξεκινάτε από τη μία άκρη πιέζοντας τη λωρίδα αμέσως μέχρι μέσα, καθώς αυτό μπορεί να της προκαλέσει ζημιά ή να σπάσει.

WARNING: Do not start from one end and press all the way in immediately, as this can cause the strip to break.

LED NEON STRIP 6×12mm 9W 12V / 24V IP67

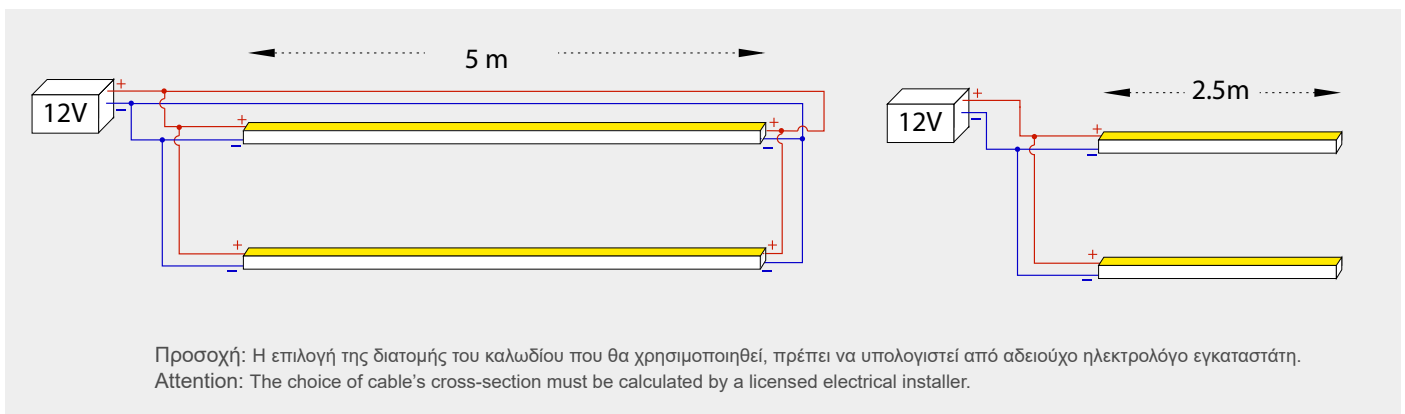
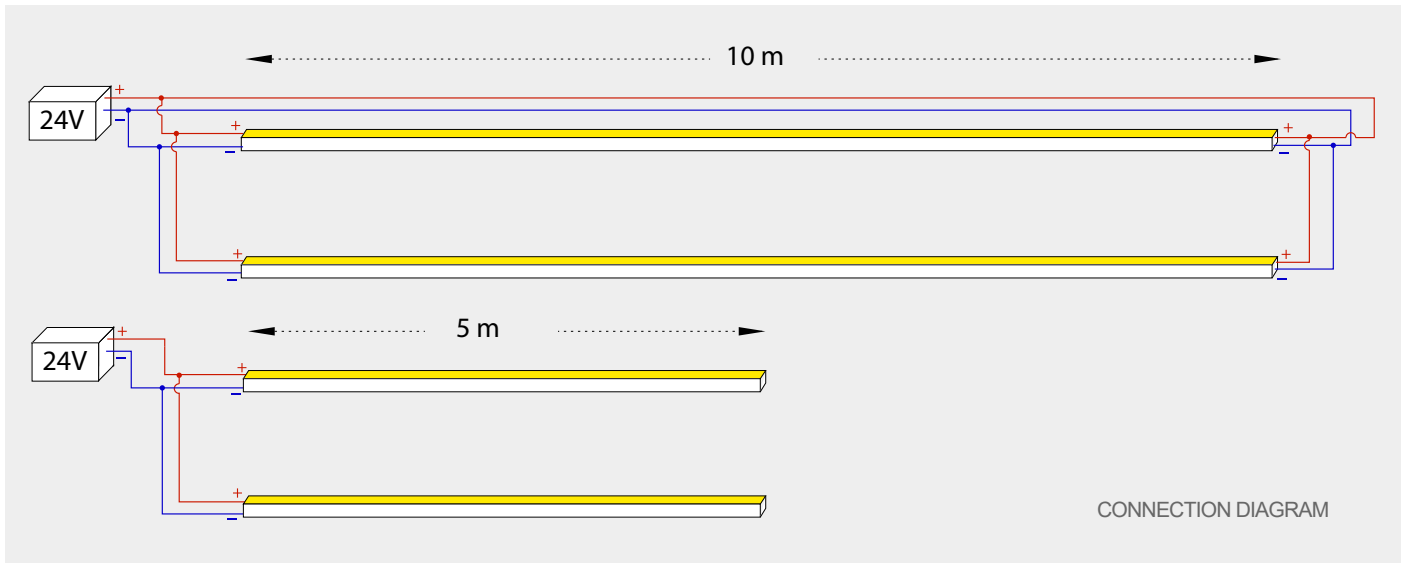

LED NEON STRIP 6×12mm 9W 12V / 24V IP67

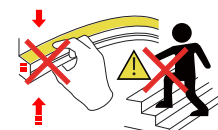
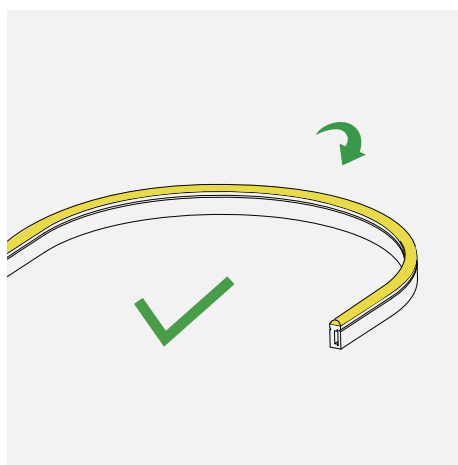
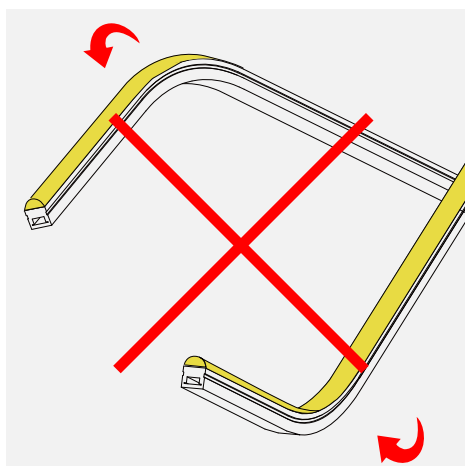

Μην πιέζετε την ταινία
No pressing



Μην στρίβετε την ταινία
No twisting



Μην τεντώνετε την ταινία
No stretching

ΠΡΟΦΥΛΑΞΕΙΣ:

1. Χρησιμοποιήστε απομονωμένο τροφοδοτικό 24V DC για τη λειτουργία της λωρίδας LED και βεβαιωθείτε ότι το τροφοδοτικό διατηρεί σταθερή τάση. Χρησιμοποιήστε μόνο το 80% της συνολικής χωρητικότητας του τροφοδοτικού για να αποφύγετε υπερφόρτωση.
2. Εξασφαλίστε την ασφάλεια κατά τη λειτουργία. Μην αγγίζετε οποιαδήποτε εξαρτήματα AC αφού ενεργοποιηθεί η λωρίδα LED.
3. Παρατηρήστε τη σωστή πολικότητα κατά τη σύνδεση των καλωδίων για να αποφύγετε πιθανή βλάβη.
4. Αποφύγετε γρατζουνιές, παραμορφώσεις ή ανώμαλη κάμψη κατά την εγκατάσταση για να διασφαλίσετε τη μακροχρόνια απόδοση της λωρίδας.
5. Μην λυγίζετε τη λωρίδα σε τόξο μικρότερο από 60mm για να διατηρήσετε την ακεραιότητα του προϊόντος.
6. Αποφύγετε να υπερβείτε το συνιστώμενο μήκος για κάθε εφαρμογή για να αποτρέψετε την υπερθέρμανση.
7. Αποφύγετε την παρατεταμένη οπτική επαφή με τη φωτιζόμενη πλευρά της λωρίδας LED για την προστασία των ματιών σας.
8. Μόνο εξειδικευμένοι επαγγελματίες πρέπει να εγκαθιστούν, να αποσυναρμολογούν και να επισκευάζουν το προϊόν.
9. Μην χρησιμοποιείτε όξιμες ή αλκαλικές κόλλες (όπως τσιμέντο γυαλιού) για την τοποθέτηση του προϊόντος.
10. Αυτό το προϊόν δεν είναι κατάλληλο για χρήση σε πισίνες ή συντριβάνια.

PRECAUTIONS:

1. Use a 24V DC isolated power supply to operate the LED strip, and ensure the power supply maintains constant voltage. Use only 80% of the power supply's total capacity to avoid overload.
2. Ensure safety during operation. Do not touch any AC power components after the LED strip is powered on.
3. Observe correct polarity when connecting wires to avoid potential damage.
4. Prevent scratches, distortions, or irregular bending during installation to ensure the strip's longevity.
5. Do not bend the strip in an arc smaller than a 60mm radius; this will help maintain product integrity.
6. Avoid exceeding the recommended length for each application to prevent overheating.
7. Avoid prolonged eye contact with the glowing side of the LED strip to protect your vision.
8. Only qualified professionals should install, disassemble, and repair the product.
9. Do not use acidic or alkaline adhesives (like glass cement) to attach the product.
10. This product is not suitable for use in swimming pools or fountains.