

- Easy maintenance
- Wide range of accessories
- Space for cable management
- Possibility to use current modules with efficiency up to 190lm/W and CRI>90. Available upon request.

APPLICATION

- main lighting

MOUNTING

- suspended or to the surface, using a dedicated mounting track, dedicated accessories or properly selected screws
- can be easily connected into runs and systems

ADDITIONAL INFORMATION

- standard lengths of KLUŚ profiles and covers: 1000 mm (tolerance ± 1.5 mm) and 2005 mm / 3010 mm (tolerance + 5 mm); for selected covers: 6050 mm, 10050 mm (tolerance + 5 mm)
- when choosing a different length of profiles / covers than available in the standard, you should additionally choose the cutting service at KLUŚ

TECHNICAL DRAWING

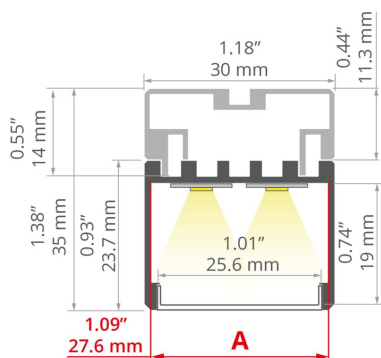

TECHNICAL SPECIFICATIONS

Material	aluminum
Color	■ silver anodized
Possible fixture IP	20
Possible fixture shapes	linear, polygonal
Profile cross-section	rectangular
Width	30 mm
Height	35 mm
LED gluing width A	27.6 mm
Number of LED strips A (8 mm wide)	3
Width of the glow	25.4 mm
Max power of a single KLUŚ LED strip	24 W/m
Possibility of obtaining a line of light	yes
Building type	Commercial, Retail, Entertainment/ Arts, HoReCa object
Facility zone	office, communication routes and corridors, conference room, lobby / foyer
The cover is cut to the length of the profile	yes

Length	Ref
1000 mm	A18039A_1
2005 mm	A18039A_2
3010 mm	A18039A_3

Profile 3035

Ref. A18039

Can be easily connected into runs	yes
Wire out back of extrusion	yes

SAMPLE PROJECTS

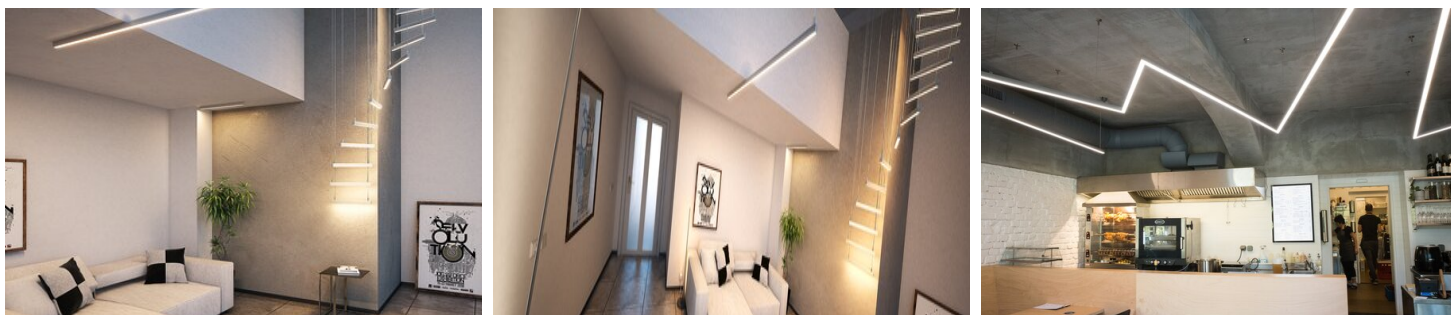

RELATED ACCESSORIES > COVERS

NAME	MATERIAL	MATERIAL TRANSMITTANCE	COLOR	REF.
Cover LIGER-25	PC	62 %	satin	B17141S

RELATED ACCESSORIES > END CAPS

NAME	MATERIAL	COLOR	REF.
End cap 3035	ABS	gray	C24273C02
End cap set 3035-HQ	aluminum	gray	C28216AS

RELATED ACCESSORIES > RELATED LED > ADJUSTABLE WHITE / DIM TO WARM



K-27T50-1440-24
K-27T50-1440-24



K-18D30-0960-24
K-18D30-0960-24

RELATED ACCESSORIES > RELATED LED > BENDABLE



K-BTRGB40-1510-24
K-BTRGB40-1510-24

RELATED ACCESSORIES > RELATED LED > CRI 95+

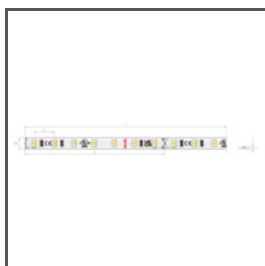

K-CR-0480-24
K-CR-0480-24

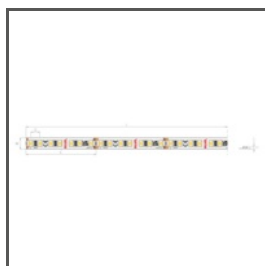

K-CR-0960-24
K-CR-0960-24

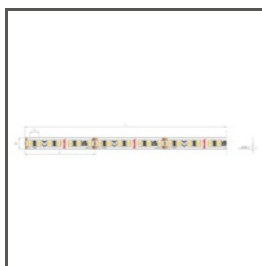

K-CR-1440-24
K-CR-1440-24

RELATED ACCESSORIES > RELATED LED > HIGH EFFICACY



K-VHE-0480-24
K-VHE-0480-24

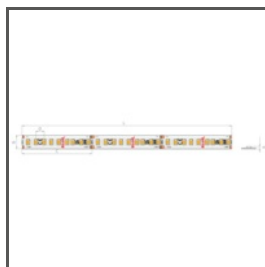

K-VHE-0960-24
K-VHE-0960-24



K-VHE-1440-24
K-VHE-1440-24

RELATED ACCESSORIES > RELATED LED > RGB / RGB-W / RGB-CCT



K-RGBW-1530-24
K-RGBW-1530-24

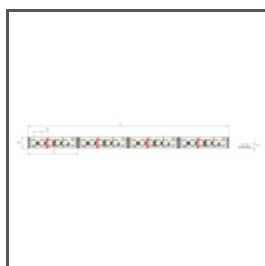

K-RGB-1920-120-24
K-RGB-1920-120-24



K-RGB-1200-24
K-RGB-1200-24



K-RGB-0700-24
K-RGB-0700-24

RELATED ACCESSORIES > RELATED LED > WHITE MONO



K-1910-HD-24
K-HD-1910-24

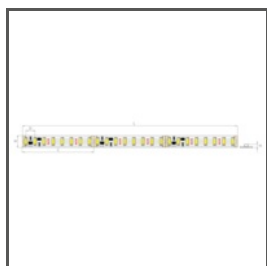

K-2300-24
K-2300-24



K-0480-24
K-0480-24

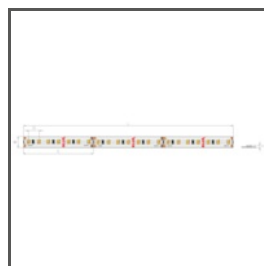

K-0960-24
K-0960-24



K-1440-24
K-1440-24

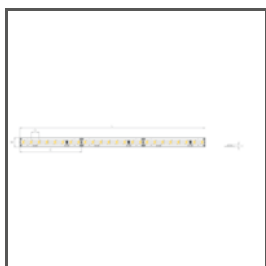

K-2400-24
K-2400-24



K-HD-0480-24
K-HD-0480-24



K-HD-0960-24
K-HD-0960-24

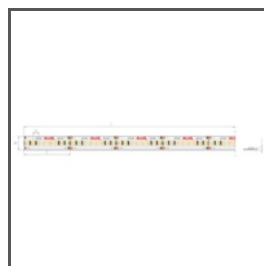

K-HD-1440-24
K-HD-1440-24

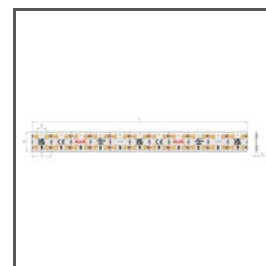

K2-1920-24
K2-1920-24



K3-2880-24
K3-2880-24

RELATED ACCESSORIES > OTHER RELATED ACCESSORIES > CANOPIES



CANOPY
Fi-60mm
C24540

RELATED ACCESSORIES > OTHER RELATED ACCESSORIES > CONDUCTIVE FASTENERS AND HEADS FOR PROFILES



HEAD
BZP-ZO
42214



FASTENER
FI-8-LIN-ZMZ
C28171N00, C28171L10,
C28171L07



FASTENER
PUSZ-LIN-ZM
C28160N00, C28160L10,
C28160L07



FASTENER
DP-ZO
00649



FASTENER
DP-ZZ
00651



FASTENER
PUSZ-LIN-MR
C28163N00, C28163L10,
C28163L07



FASTENER
PUSZ-PRET-ZM
C28161N00, C28161L10,
C28161L07



FASTENER
PUSZ-PRET-LEB
C28165N00, C28165L10,
C28165L07

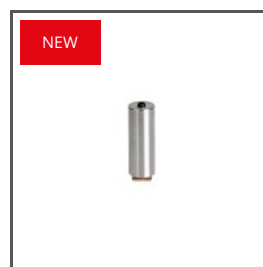

FASTENER
PUSZ-ZM
C20010

RELATED ACCESSORIES > OTHER RELATED ACCESSORIES > CONNECTORS



CONNECTOR
ZM



CONNECTOR
ZM-MINI
44501, C28083N00

RELATED ACCESSORIES > OTHER RELATED ACCESSORIES > FASTENERS AND HEADS FOR PROFILES

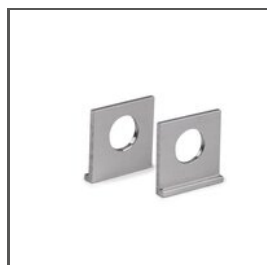

FASTENER
UCHO-ZM
C28192N00, C28192L07



FASTENER
FI-10-ZM-P
C28117N00

RELATED ACCESSORIES > OTHER RELATED ACCESSORIES > ISOLATING BASES



ISOLATING BASES
ARMSTRONG
C28241C10

RELATED ACCESSORIES > OTHER RELATED ACCESSORIES > LATCHES



ADAPTERS SET
ZM-16
C29001C00

RELATED ACCESSORIES > OTHER RELATED ACCESSORIES > OTHER



GLAND
M8x1
C42265N00



GLAND
M10x1
C28275N00

RELATED ACCESSORIES > OTHER RELATED ACCESSORIES > SPRINGS FOR RECESSED MOUNT AND MOUNTING TRACKS

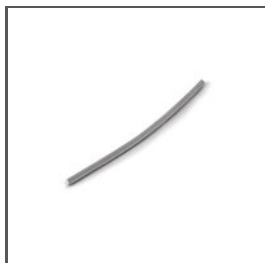

SPRING
BLOK
C42731N00

RELATED ACCESSORIES > OTHER RELATED ACCESSORIES > SURFACE SPRINGS

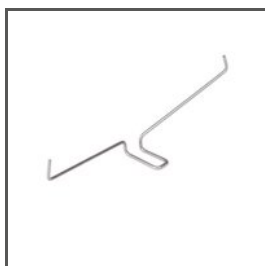

SPRING
GP
C24500N00

RELATED ACCESSORIES > OTHER RELATED ACCESSORIES > SUSPENSION AND MOUNTING SETS

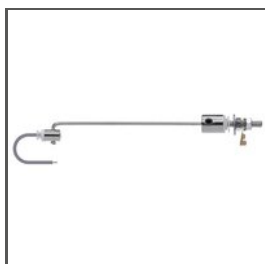

FASTENER SET
M12
42610

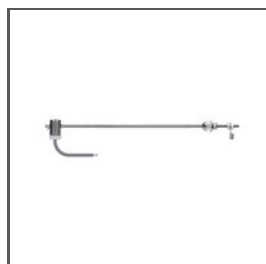

FASTENER SET
M13
42611

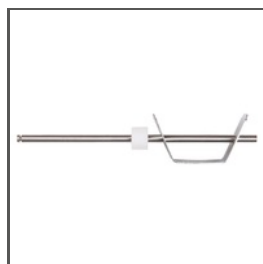

FASTENER
ZM-150
42118

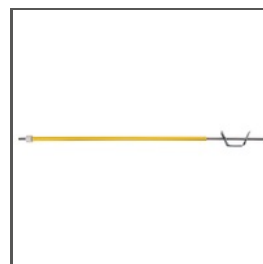

FASTENER
ZM-500
42119



FASTENER SET
RG-1
C28230P00, C28230P01,
C28230L10, C28230L07



FASTENER SET
RD-1
C28231



FASTENER SET
RD-2
C28232P00, C28232P01,
C28232L10, C28232L07



FASTENER SET
RD-3
C28233P00, C28233P01,
C28233L10, C28233L07



FASTENER SET
RD-4
C28234P00, C28234P01,
C28234L10, C28234L07

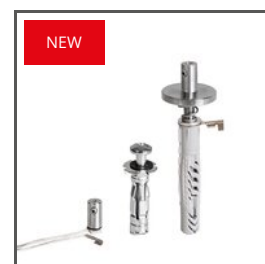

FASTENER SET
FI-8-ZM-1
C28134

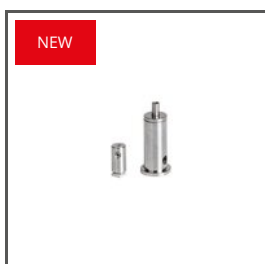

FASTENER SET
FI-8-ZM-2
C28135

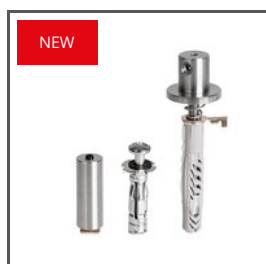

FASTENER SET
PUSZ-ZM-1
C28130

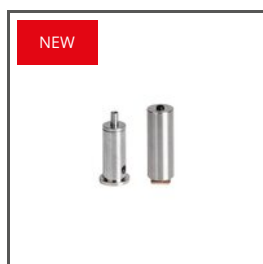

FASTENER SET
PUSZ-ZM-2
C28131

RELATED ACCESSORIES > ELECTRONICS > SWITCHES



UNI-11
E61603



UNI-P
E61580