

Fastener FI-10-ZM-P

Ref. C28117N00

Ref. arch 42244

- Transverse suspension on a rod or cable
- Small dimensions

APPLICATION

- for suspending LED lighting fixtures

MOUNTING

- to a rod or cable, using a set bolt
- to the rod with a pressure screw



TECHNICAL DRAWING

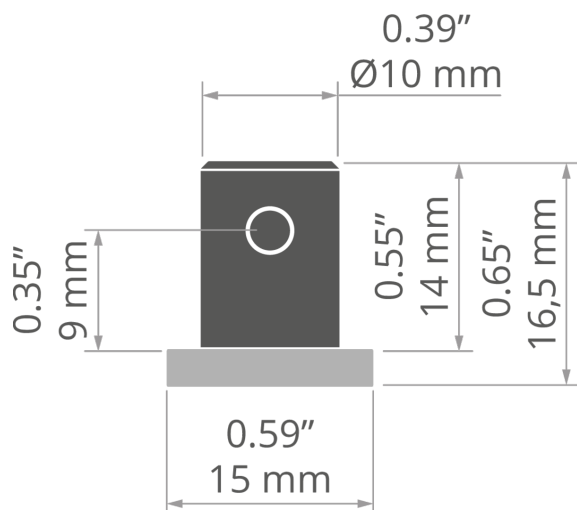

TECHNICAL SPECIFICATIONS

Material	stainless steel
Color	■ silver
Width	15 mm

Height	16.5 mm
Lifting capacity	30 kg

Fastener FI-10-ZM-P

Ref. C28117N00

Ref. arch 42244

RELATED PROFILES > ARCHITECTURAL



3035
A18039
Ref. arch 18039



3035-O
A08441
Ref. arch B8441



4050
A18050
Ref. arch 18050



4050-W
A18051
Ref. arch 18051



GIZA
A05556
Ref. arch B5556

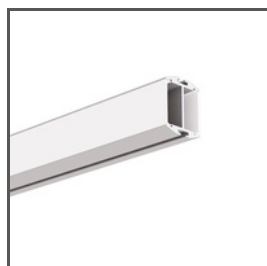

GIZA-DUO-LL
A02162
Ref. arch C2162



GIZA-LL
A00758
Ref. arch C0758

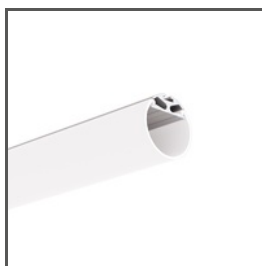

JAZ
A08547
Ref. arch B8547



LIPOD
A05554
Ref. arch B5554



OPK-4
A00370
Ref. arch C0370

RELATED PROFILES > FOR MAIN LIGHTING

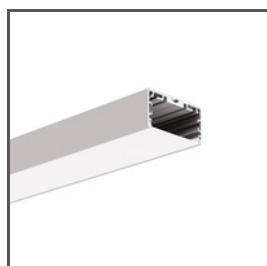

LIPOD-50
A02609
Ref. arch C2609

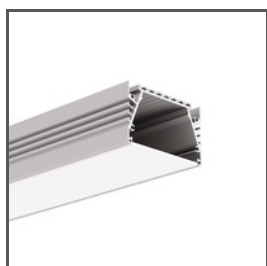

SEPOD
A06593
Ref. arch B6593

RELATED PROFILES > MINIMALISTIC



PIKO-ZM
A01168
Ref. arch C1168

RELATED PROFILES > UNIVERSAL

Fastener FI-10-ZM-P

Ref. C28117N00

Ref. arch 42244



OLEK

A08505

Ref. arch B8505



PDS-ZM-PLUS

A02056

Ref. arch C2056

RELATED SYSTEMS > GENERAL LIGHTING SYSTEMS

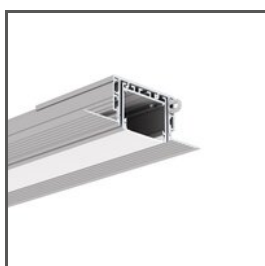

3035-KOZE

A08441+A18056

Ref. arch 18056+B8441



PK-4

A18044+A00370

Ref. arch 18044+C0370

RELATED ACCESSORIES > OTHER RELATED ACCESSORIES > WIRES AND RODS

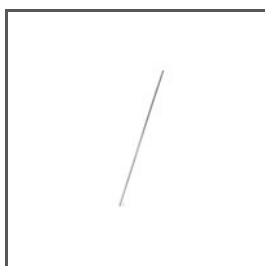

ROD

FI-3 1m

42501

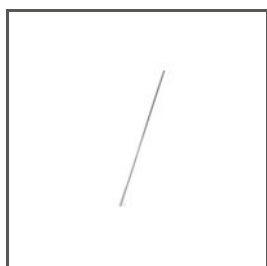

ROD

100 PUSZ 1 m

42518

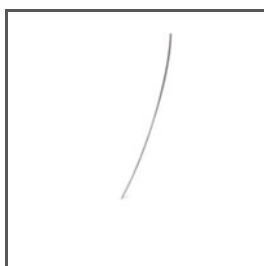

ROD

FI-3 53 cm

C24528N00

Ref. arch 1528



ROD

FI-3-ALU

C28196A01, C28196A07

Ref. arch 42526, 42527, 42528, 42529