

Profile HR-OPTI

Ref. A01844

Ref. arch C1844

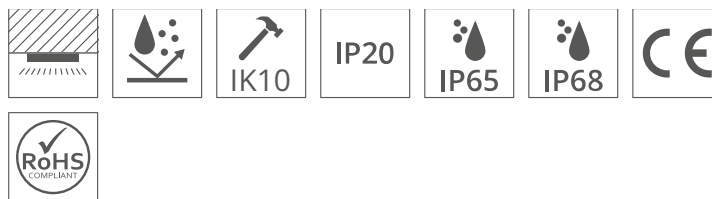
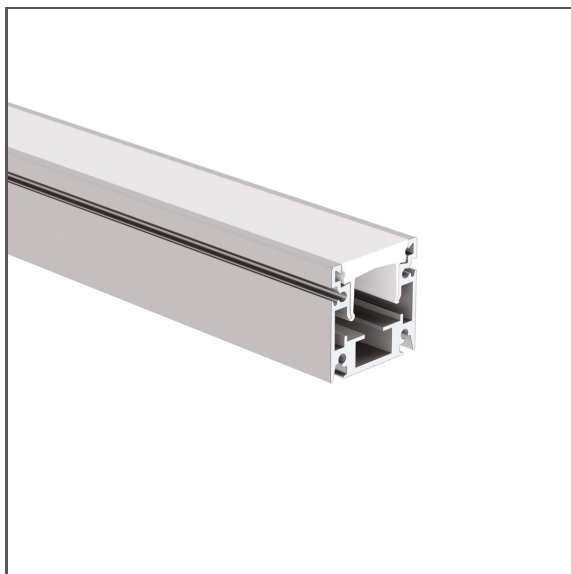

- For installation on facades
- Designed for IP68 and IK10 protection ratings
- Corrosion resistance at high salinity
- Corresponds to the width of the HR-MAX facade system
- Adjustable lighting angle

APPLICATION

- decorative lighting

MOUNTING

- to the surface, using dedicated accessories

ADDITIONAL INFORMATION

- possibility to fasten the lighting fixture with the back or side to the mounting surface
- possibility of smooth transition from a facade into an in-ground lighting fixture
- standard lengths of KLUŚ profiles and covers: 1000 mm (tolerance ± 1.5 mm) and 2005 mm / 3010 mm (tolerance + 5 mm); for selected covers: 6050 mm, 10050 mm (tolerance + 5 mm)
- when choosing a different length of profiles / covers than available in the standard, you should additionally choose the cutting service at KLUŚ

TECHNICAL DRAWING

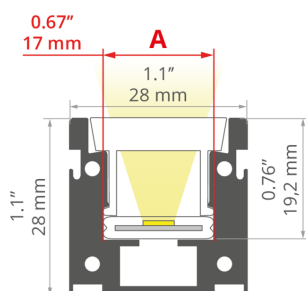

TECHNICAL SPECIFICATIONS

Material	aluminum
Color	■ silver anodized
Possible fixture IP	20, 65, 68
Possible fixture shapes	linear
Profile cross-section	rectangular
Width	28 mm
Height	28 mm
LED gluing width A	17 mm
Number of LED strips A (8 mm wide)	2
Lighting angle adjustment up to	240
Corrosion resistance at high salinity	yes
Impact protection IK10	yes
Building type	Outdoor, Commercial, Retail, HoReCa object
Facility zone	urban architecture, facade lighting, wall lighting, green architecture
The cover is cut to the length of the profile	yes
Wire out back of extrusion	yes

Length	Ref
1000 mm	A01844A_1 C1844ANODA_1
2005 mm	A01844A_2 C1844ANODA_2
3010 mm	A01844A_3 C1844ANODA_3

Profile HR-OPTI

Ref. A01844

Ref. arch C1844

SAMPLE PROJECTS

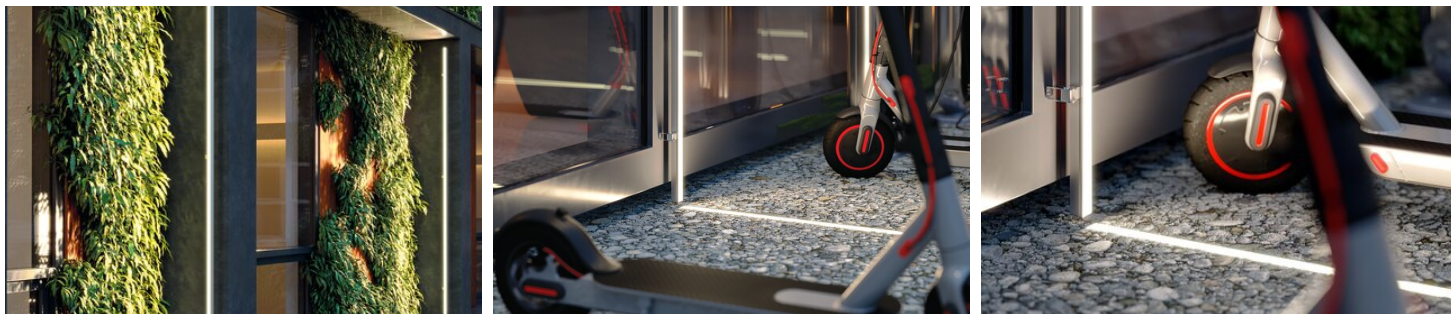





RELATED ACCESSORIES > RELATED COVERS

NAME	MATERIAL	MATERIAL TRANSMITTANCE	COLOR	REF.
HR-21	 PMMA	45 %	<input type="checkbox"/> frosted	B17152M 17152

RELATED ACCESSORIES > RELATED END CAPS

NAME	MATERIAL	COLOR	REF.
HR-OPTI-STN	 stainless steel	<input checked="" type="checkbox"/> gray	C28019N00 24387

RELATED ACCESSORIES > OTHER RELATED ACCESSORIES > MOUNTING BRACKETS

 NEW	 NEW	 NEW	 NEW	 NEW
MOUNTING BRACKET HR-OPTI-45 C28091N00 Ref. arch 42125	MOUNTING BRACKET HR-OPTI-75 C28092N00 Ref. arch 42138	MOUNTING BRACKET HR-OPTI-90 C28093N00 Ref. arch 42170	MOUNTING BRACKET HR-OPTI-105 C28094N00 Ref. arch 42126	MOUNTING BRACKET HR-OPTI-155 C28095N00 Ref. arch 42124

Profile HR-OPTI

Ref. A01844

Ref. arch C1844



MOUNTING BRACKET

HR-OPTI

C28090N00

Ref. arch 42121

RELATED ACCESSORIES > OTHER RELATED ACCESSORIES > OTHER



HERMETIC COUPLER

C28239C02

Ref. arch 42702



GLAND

M16x1,5

C42271C02

Ref. arch 42271



ANGULAR GLAND

M16x1,5-L90

C28158C02

Ref. arch 42289