

# SPOT R50



## ΠΕΡΙΕΧΟΜΕΝΑ / CONTENTS

datasheet	1
manual	2

## ΚΩΔΙΚΟΣ / CODE

SR5- XX-XX-XX-XX-XX-XX-XX-XX-XX-XX

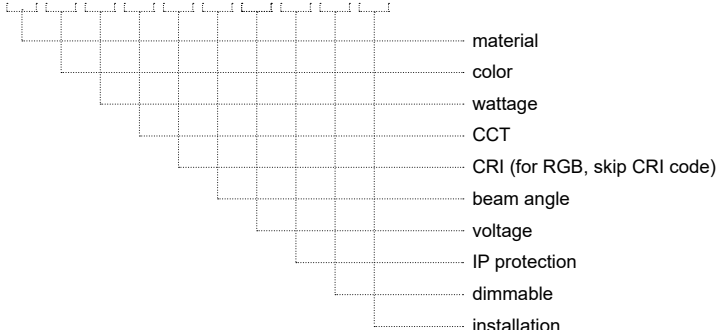

## SPOT R50 (SR5) / Datasheet

To κουτί τοποθέτησης περιλαμβάνεται / Installation box is included

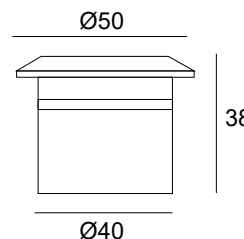
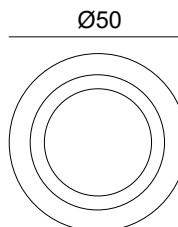

### general information

Application	Outdoor / Recessed
Direction of mounting	Ceiling / Wall / Ground
LED	Cree / Osram
Life time	50000 hrs
Warranty	3-5 years (*5 years upon request)
Origin	Greece
Visible dimensions (Ø×L)	Ø50 × 38 mm

Η εγκατάσταση γίνεται είτε με χωνευτό κουτί εγκατάστασης είτε με ελατήρια.

The installation is done either by recessed installation box or with springs.

material	color	wattage	CCT	CRI	beam angle	Voltage	IP	Dimmable	installation
Aluminium (01)	Anodised (AN)	0.5W (05W)	2700K (27K)	Ra80 (80)	Diffuse (DF)	12VDC (V1)	IP20 (20)	Yes (D)	Box (IB)
Inox (02)	Black (BL)	1W (1W)	4000K (40K)	Ra90 (90)	8° (8D)	24VDC (V2)	IP54 (54)	No (L)	Springs (IS)
Brass (03)	White (WH)	2W (2W)	5000K (50K)		15° (15D)	230VAC (V3)	IP65 (65)		
PVC (04)	RAL colors (RL)	2.5W (25W)	(R) / (G) / (B) / (AM)		20° (20D)	12/24V (V4)	IP67 (67)		
		3W (3W)	RGB (C1)		25° (25D)	350mA (V5)	IP68 (68)		
					36° (36D)	500mA (V6)			
					45° (45D)	700mA (V7)			
					60° (60D)				
					80° (80D)				

Δημιουργία Κωδικού προϊόντος / Product Code generator

SR5 - material - color - wattage - CCT - CRI - beam angle - voltage - IP - dimmable - installation

(ex. SR5-01-AN-1W-27K-80-8D-V1-54-D-IB for Spot R50 Aluminium Anodised 1W 2700K Ra80 8° 12VDC IP54 Dimmable Box)

## SPOT R50 / Manual

1. ΠΡΟΕΤΟΙΜΑΣΙΑ ΤΟΥ ΕΔΑΦΟΥΣ / PREPARATION OF TERRAIN
2. ΚΑΝΕΤΕ ΤΗΝ ΗΛΕΚΤΡΙΚΗ ΣΥΝΔΕΣΗ / MAKE THE ELECTRICAL CONNECTION
3. ΤΟΠΟΘΕΤΗΣΗ ΤΟΥ ΦΩΤΙΣΤΙΚΟΥ / PLACE THE LUMINAIRE (a. επιδαπέδια/ground | b. χωνευτο/recessed)

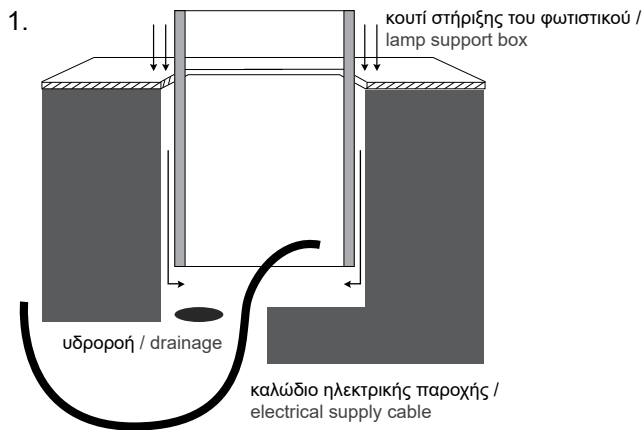

2.

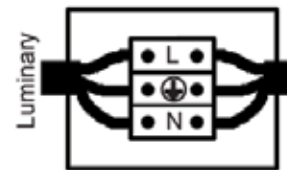

Συνδέστε το καλώδιο του φωτιστικού με την ηλεκτρική παροχή. Η σύνδεση πρέπει να είναι στεγανή. / Connect the cable of the luminaire with the electrical supply. The connection must be sealed.

3.a Εφαρμογή στο έδαφος με O-ring / Application on ground using O-ring

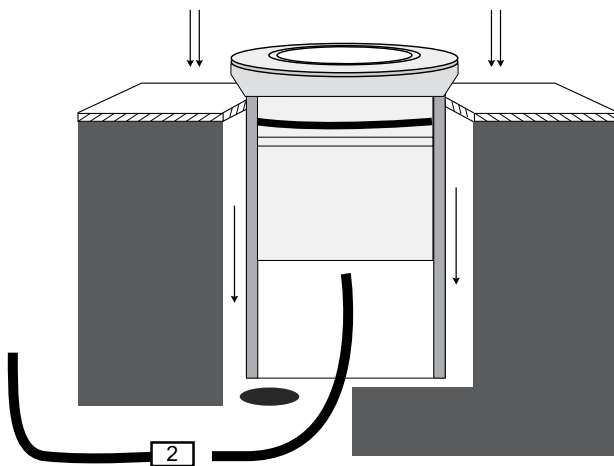

Εφαρμόστε το φωτιστικό στο κουτί εγκατάστασης μέχρι να σφινώσει και να σταθεροποιηθεί. / Apply the luminaire to the installation box until it is firm and stabilized.

3.b Εφαρμογή στον τοίχο με ελατήρια / Application on wall using springs

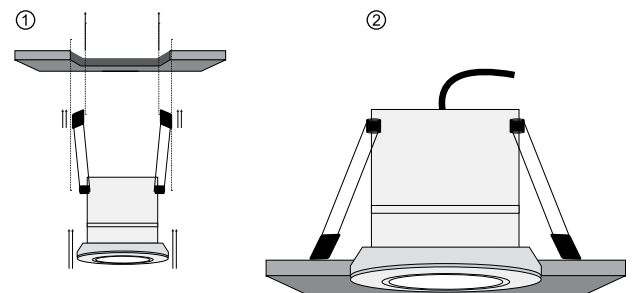

① Κρατήστε τα ελατήρια προς τα πίσω για να περάσουν πρώτα αυτά από την οπή και έπειτα ② αφήνετε το φωτιστικό σιγά σιγά μέχρι να εφαρμόσει στην οροφή. / ① Hold the springs backwards to get them through the cutter first and then ② slowly leave the lamp until it applies into the roof.