

TITE R40 BASE PVC

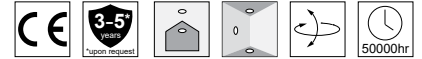

ΠΕΡΙΕΧΟΜΕΝΑ / CONTENTS

Datasheet	1
Manual	3

SKU: TITEBR40PC- XX-XX-XX-XX-XX-XX-XX-XX-XX-XX

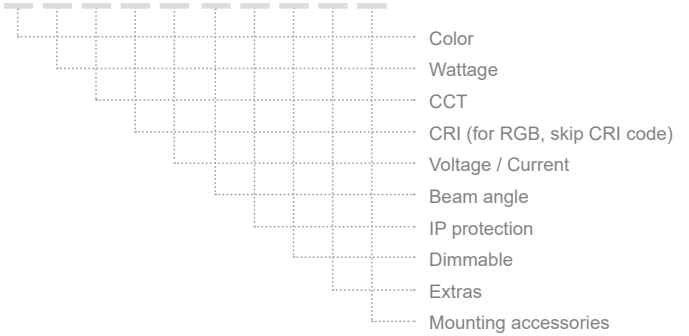

TITE R40 BASE PVC (TITEBR40PC-) / Datasheet

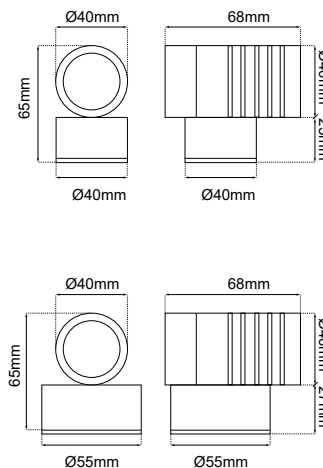

















GENERAL INFORMATION





APPLICATION	Outdoor / Surface mounted
DIRECTION OF MOUNTING	Ceiling / Wall / Ground
MATERIAL	PVC
VISIBLE DIMENSIONS (Ø×L)	Ø40 × 68 mm
INCL. CABLE	Yes
LED TYPE	XTE/XRE/XPE/NICHIA/GU10
LIFE TIME	50000 hours
WARRANTY	3–5 years (*5 years upon request)
ORIGIN	Greece

TITE R40 BASE PVC / Datasheet

SKU: TITEBR40PC- XX-XX-XX-XX-XX-XX-XX-XX-XX-XX

COLOR
WATTAGE
CCT
CRI (skip for RGB)
VOLTAGE / CURRENT
BEAM-ANGLE
IP PROTECTION
DIMMABLE
EXTRAS
MOUNTING-ACCESSORIES

Color	Wattage	CCT	CRI	Voltage / Current	Beam Angle
None (gray) (L) 	0.5W (05W)	2700K (27K) 	Ra80 (80)	12VDC (V1)	Diffuse (DF) 
Patina (PT) 	1W (1W)	3000K (30K) 	Ra90 (90)	24VDC (V2)	8D (8D) 
	2W (2W)	4000K (40K) 		230VAC (V3)	15D (15D) 
	2.5W (25W)	5000K (50K) 		12/24V (V4)	20D (20D) 
	3W (3W)	6000K (60K) 		350mA (V5)	35D (35D) 
		(R) / (G) / (B) / (A) 		500mA (V6)	40D (40D) 
		RGB (C1) 			60D (60D) 
					80D (80D) 

IP	Dimmable	Extras	Extras
IP65 (65)	Yes (D)	Shadow (SH) 	Base R40x25mm (B2) 
IP66 (66)	No (L)	Honeycomb (HC) 	Base R55x27mm (PL1) 
IP67 (67)		None (L)	

Δημιουργία Κωδικού προϊόντος / Product Code generator

TITEBR40PC- material - color - wattage - CCT - CRI - voltage - beam angle - IP - dimmable - extras - extension - mounting accessories

EXAMPLE:

TITEBR40PC - 01-BL-3W-27K-90-V1-15D-65-D-SH-HC -H30-MB1

for TITE R40 BASE PVC, aluminium, black, 3W, 2700K, Ra90, 12VDC, 15°, IP65, dimmable, shadow and honeycomb - branch of height 300mm, base R40x27)

TITE R40 BASE PVC / Manual

ΟΔΗΓΙΕΣ ΕΓΚΑΤΑΣΤΑΣΗΣ INSTALLATION INSTRUCTIONS

1.

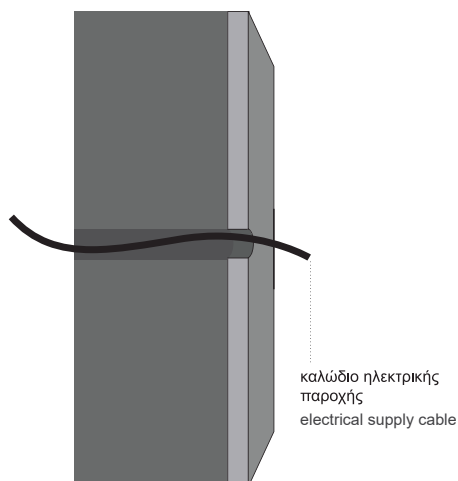

2.

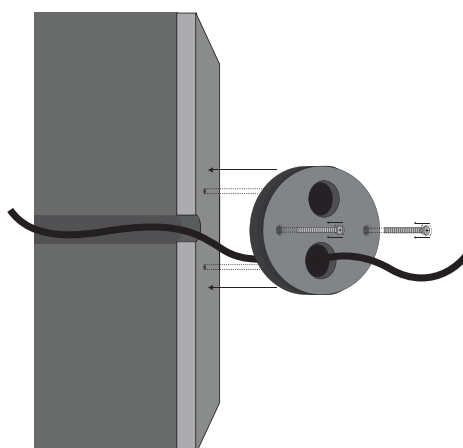

3.

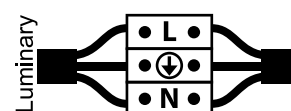

Συνδέστε το καλώδιο του φωτιστικού με την ηλεκτρική παροχή.

Connect the cable of the luminaire with the electrical supply.

4.

Εφαρμογή στον τοίχο
Application on the wall

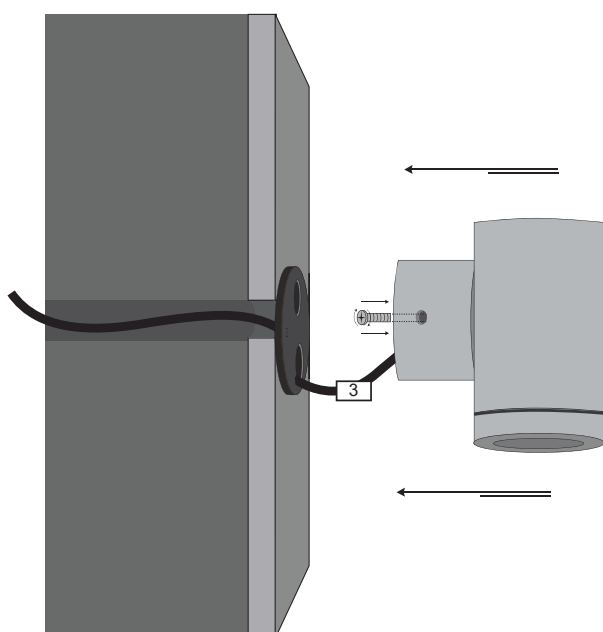

5.

Εφαρμόστε το φωτιστικό στην τοποθετημένη βάση και βιδώστε το πάνω της με δεξιόστροφη περιστροφή μέχρι να σταθεροποιηθεί.
Apply the lamp to the mounted base and tighten it with a clockwise rotation until it is firmly stabilized on the base.

